

For warranty details, or general trim tab operation information, visit [BennettTrimTabs.com](http://BennettTrimTabs.com).

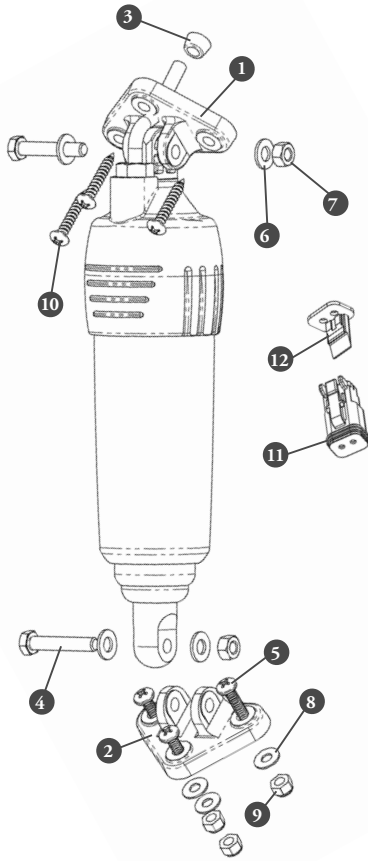

**Triangular Upper Hinge Base Option**

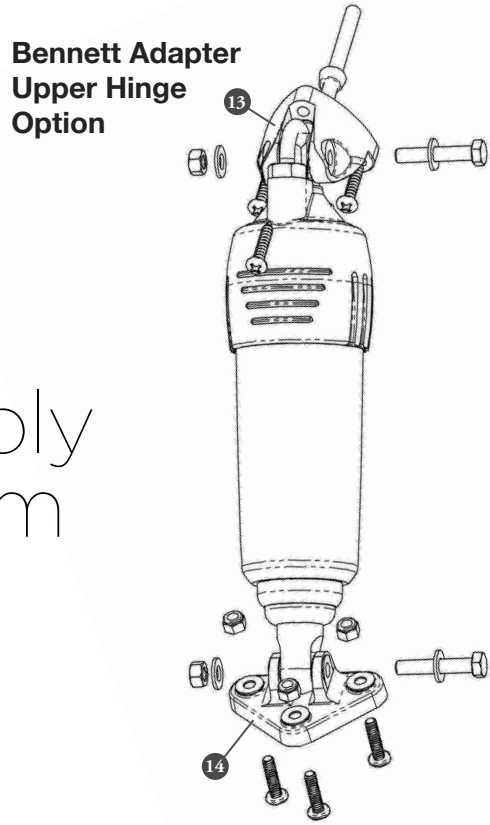

**Bennett Adapter Upper Hinge Option**

Kit Part Number:  
BOLTLKCON

## Assembly Diagram

PART	PART NO.	QTY.
1 BQE Upper Hinge, Triangular Base (W/ Thru Hole)	BQE86-2	2
2 BQE Lower Hinge, Triangular Base (No Thru Hole)	BQE86-1	2
3 BQE Upper Hinge Grommet	BQE87	2
4 Hex Head Bolt 5/16-18 x 1-3/4, 18-8 SS	ML432	4
5 Screw Mach Pan Head PHI 1/4-20 X 1.0, 18-8 SS	ML433	6
6 .032" Flat Washers, 18-8 SS	ML450	8
7 Low Profile Hex Nut, 18-8 SS	ML453	4

PART	PART NO.	QTY.
8 1/4" X 5/8 Flat Washer, 18-8 SS	ML294	6
9 1/4-20 Nylon Locking Nut SS, 18-8 SS	ML267	6
10 Screw # 14 x 1-1/2 SMS, 18-8 SS	HP2	6
11 Waterproof Plug, 2 Pos, 16 Gauge	ML343	1
12 Wedge Lock Plug, Waterproof 2 Pos.	ML345	1
13 BQE Upper Hinge, Bennett Adapter	BQE82	2
14 BQE Lower Hinge, Triangular Base	ACT1	2

### How To Determine Compatibility

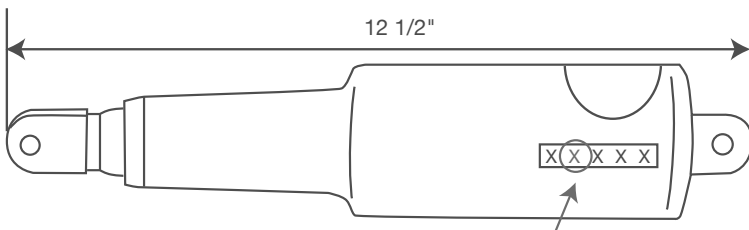

Bennett Lenco-to-BOLT Upgrade Kit is compatible with Lenco "Standard Mount", "Standard Performance", and "Edge Mount" systems.

To determine whether or not your Lenco actuators meet the Compatibility requirements, locate the identification stamp (available since approximately May 2008). The actuator type is indicated by the second number in the 5-digit code.

Lenco actuators with either "A", "B" or "G" indicated as the second digit in the 5-digit code sequence are compatible with the Bennett Lenco-to-BOLT Upgrade Kit.

Short stroke Lenco actuators (11-3/8" and 10-7/8" actuator length), and long stroke Lenco actuators (14" and 13" actuator length) are NOT compatible.

## Before Installation

The actuator replacement must be done when the vessel is out of the water. Do not attempt to replace the actuators while the vessel is in the water as the actuators are mounted below the water line.

Before performing any electrical work on a vessel, disconnect the battery by removing the positive (+) cable or if equipped, turning the battery disconnect switch to the OFF position.

## Installation of Adjustable Upper Hinge (BEA3000)

### To Remove an Existing Lenco Actuator

- Unplug the wiring harness connection from the actuator to the relay control module.



- Cut off the wiring harness connector from the actuator cable so it can pass through the transom hole.

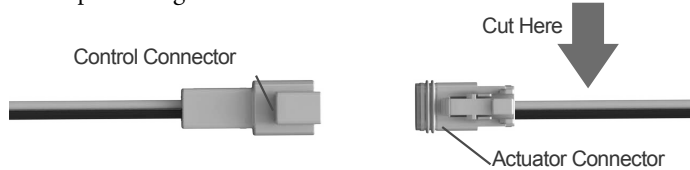

### ⚠ Only cut the wires coming from the actuator.

- Unbolt the lower hinge mount from the Lenco actuator by removing the 5/16-18 lock nut and bolt using a 1/2" wrench.
- Unscrew the lower hinge mount of the Lenco actuator from the trim tab by removing the (3) 1/4-20 x 1" long Phillips head screws and nuts using a #3 Phillips head screw driver and a 7/16" wrench.
- Clean the tab of any paint and/or barnacles.
- Allow the Trim Tab to swing down and out of the way.
- Unbolt the Lenco actuator from the adjustable upper hinge by removing the 5/16-18 lock nut and bolt using a 1/2" wrench. (Figure 1)
- Allow the Lenco actuator to hang by the wire.
- Unscrew the upper hinge mount of the Lenco actuator from the transom by removing the (3) #14 x 1-1/2" long screws using a #3 Phillips head screw driver. (Figure 2)
- The actuator can then be removed. Take care to gently pull the electrical wires through the transom hole.
- Clean the hull using a sharp blade to remove any old sealant from the actuator mounting locations. Wipe clean using a solvent.



### To Remove an Existing Lenco Actuator

- The supplied kit contains 2 different upper hinge mounting options. Compare the new upper hinges to the old Lenco upper hinge and use the upper hinge that matches the bolt pattern of the old actuator. Disregard the other pair of upper hinge mounts as they will not be used.

Compatible with Lenco hole pattern



Compatible with Bennett hole pattern



- Carefully insert the end of the electrical cable through the adjustable upper hinge mount and install the sealing grommet onto the cable.

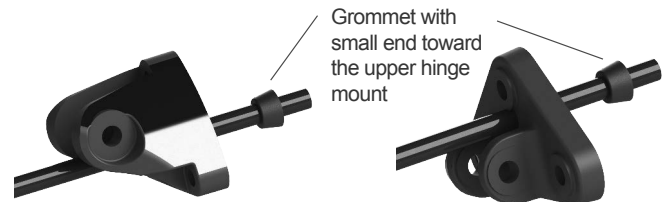

- Pull the cable through the mount until the mount is about 8" from the actuator.
- Insert the end of the cable through the transom hole.
- Temporarily mount the actuator to the adjustable upper hinge using the supplied 5/16-18 bolt and lock nut (using a 1/2" wrench) to set the cable length.
- Temporarily mount the upper hinge of the new actuator to the transom using (2) of the supplied #14 x 1-1/2" screws in the lower mounting positions, leaving a gap of 1/4" between the upper hinge and the transom. Pull the excess cable through the transom leaving enough cable to prevent the actuator from binding during its normal movement.

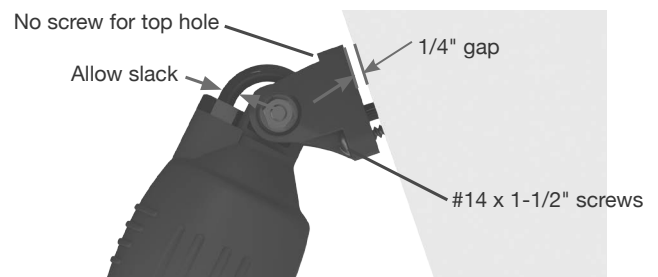

- Ensure that the cable sealing grommet is moved down the cable to its seat on the upper hinge.

- Swing the actuator through its maximum range of motion to ensure there is the proper amount of cable to allow movement without binding.

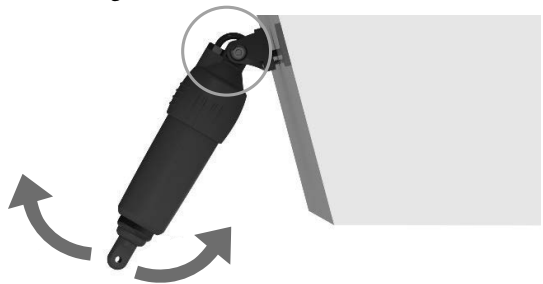

- Unscrew the two #14 x 1-1/2" screws holding the adjustable upper hinge and pull back from the transom making sure the cable length does not change.
- Apply 3M 5200 waterproof sealant on the mounting surface and around the wiring of the new actuator.



- Screw the adjustable upper hinge to the transom using (2) of the supplied #14 x 1-1/2" screws in the lower 2 mounting positions.



- Remove the BOLT actuator from the upper hinge allow the actuator hang.

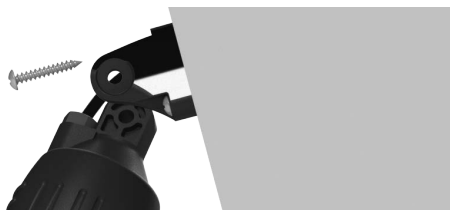

- Install the remaining (1) #14 x 1-1/2" screw into the top position of the hinge.
- Install the BOLT actuator to the upper hinge using the supplied 5/16-18 bolt and nut. Make sure not to over-tighten as the actuator needs to rotate within the hinge.
- Over-tightening will cause the actuator to bind. Do not collapse upper hinge mount uprights.
- Tighten until the bolt and nut contact the flanges of the upper hinge. There should be a gap between the uprights of the upper hinge mount and the flanges on the actuator.

- Install the lower hinge mount to the BOLT actuator using the supplied 5/16-18 bolt, washers, and lock nut. Do not to over tighten as the actuator.
- Install the lower hinge mount to the trim tab using the (3) supplied 1/4-20 x 1" screws and nuts using a 1/2" wrench.

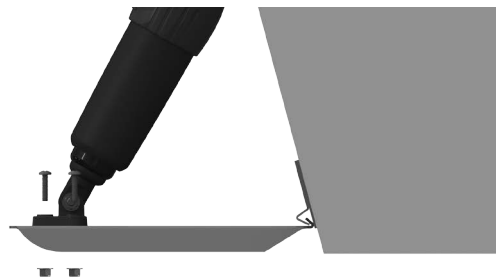

- Install the wiring connector onto the wires:
  - » Insert the black wire into location pin #1, insert the white wire into location pin #2 into the back of the connector until the pin locks into place.
  - » Ensure the proper wire color is on the correct side of the connector by comparing the old connector that was cut off.
  - » Install the orange plastic wedge retainer into the front of the connector.

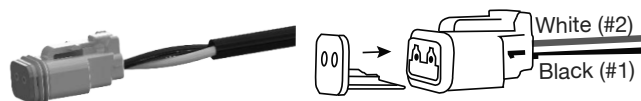

- **Note:** Older Lenco systems may not have a waterproof connector. If your system does not have waterproof connectors, cut the crimped sockets off the actuator wires and connect using heat shrinkable butt splices (not splices).
- Connect the male wiring connector to female wiring connector coming from the relay module. For help with connectors visit [BennettTrimTabs.com/ConnectorHelp](http://BennettTrimTabs.com/ConnectorHelp).
- Reconnect the positive (+) battery cable or turn battery disconnect switch to the ON position and check the system for functionality.
- If the actuators are working backwards, the wires are reversed. Refer to the troubleshooting section on the reverse page.

## Troubleshooting

- **Symptom:** Actuators work reverse.
  - » Wires installed backwards. Remove wires from connectors and reverse.
  - » For help with connectors visit [BennettTrimTabs.com/ConnectorHelp](http://BennettTrimTabs.com/ConnectorHelp).
- **Symptom:** Actuator not working at all.
  - » Check fuse
  - » Check output of switch or control using a volt meter. Connect meter leads to wire harness leads and press control or switch.
  - » Caution: Do not allow wire harness leads to touch as control is pressed or a short circuit will occur.
  - » Switch meter should show (+)12VDC or (-)12VDC. If there is no output from the controls, the Lenco controls are defective. Call Bennett Marine for replacement options or visit [BennettTrimTabs.com](http://BennettTrimTabs.com).

## Need Installation Help?

We're here to assist.

Call Bennett Marine at (954) 427-1400.

*For warranty details, or general trim tab operation information, visit [BennettTrimTabs.com](http://BennettTrimTabs.com).*



[BennettTrimTabs.com](http://BennettTrimTabs.com)