

TRIM TAB INSTALLATION INSTRUCTIONS

READ INSTRUCTIONS COMPLETELY BEFORE BEGINNING INSTALLATION

Materials/Tools:

Vise Grips

Wire Stripper

$\frac{7}{64}$ ", $\frac{9}{64}$ ", $\frac{3}{32}$ ", $\frac{3}{16}$ ", $\frac{5}{32}$ " & $\frac{1}{2}$ " Drill Bits

$\frac{1}{2}$ " & $\frac{9}{16}$ " Wrenches

Tape Measure

Teflon Tape

Automatic Transmission Fluid

Electric Drill

Masking Tape

Marine Epoxy

#1, 2 & 3 Phillips Head Screw Drivers

4-ft. Straight Edge

Wire Cutters

Small Funnel

2 $\frac{1}{2}$ " Hole Saw for Euro-Style Rocker

Switch Control

Marine Grade Sealant

Wire Crimpers

Step 1 — Position the trim tabs against the transom and check to see that the upper mounts of the hydraulic actuators do not center on an inside obstruction. If they do, reposition tabs slightly outboard. The further outboard the tabs are mounted, the greater the lateral (side-to-side) control. Position tabs 3" to 4" from the chine (side of boat) and run towards the centerline of the boat. Boats with outboard motors or inboard/outboards (I/Os) must maintain a minimum of 8" from the centerline of outboard or stern drive unit to the closest edge of the trim tabs. Boats with inboard motors may utilize the entire run of the transom. (See Figures 1 & 2)

Figure 1

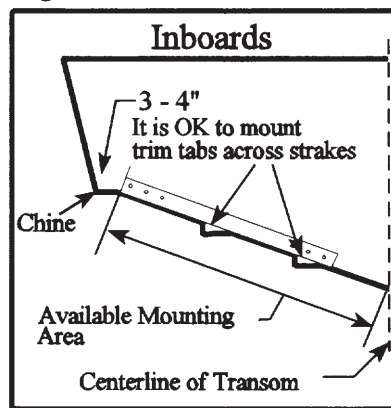
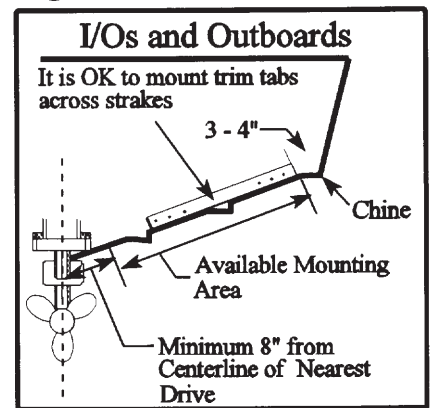

Figure 2



Note: If the inside of the transom is inaccessible due to fuel tank, flotation, or other obstruction, call Bennett Marine for alternate installation options at (954) 427-1400.

Figure 3

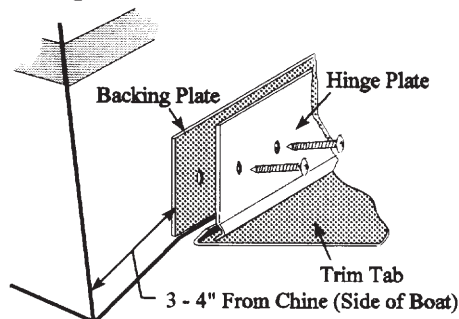

Figure 4

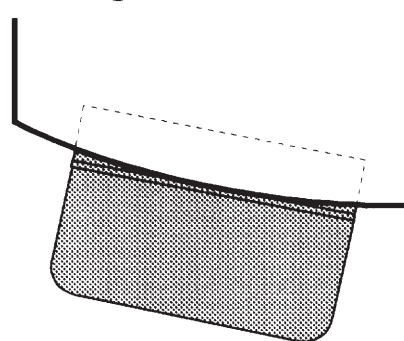
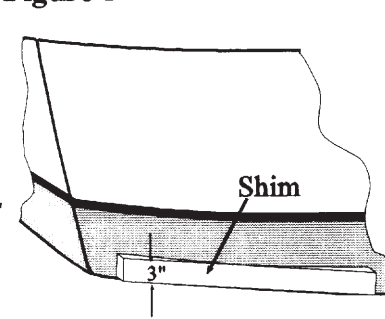

Figure 5



Step 2 — Attach the mounting plates and trim tab with #10 x 1- $\frac{1}{4}$ " stainless steel screws along the bottom of the transom. (See Figure 3) Using the backing plate as a template, mark screw hole locations. Drill $\frac{9}{64}$ " pilot holes for mounting screws and test. If the pilot holes are too tight, enlarge with a $\frac{5}{32}$ " drill bit. Assemble backing plates and hinge plates, dip screws in marine epoxy before running in. Slide trim tab between backing plate and hinge plate before running screws tight. Snug screws down to secure mounting plates and trim tab to transom. Aluminum boats should use machine screws and nuts (not included) instead of the enclosed #10 x 1- $\frac{1}{4}$ " self-tapping stainless steel screws. If the tabs are bottom mount style, the one piece mounting plate is secured to the bottom of the boat with the hinge curl touching the transom and with an equal space at each end of the curl (See Figure 4). If the transom is curved and transom mount style tabs are being installed, a shim must be made of a suitable material to provide a flat mounting surface. (See Figure 5)

Step 3 — Secure the lower hinge of each actuator to the tab with 1/4-20 x 3/4" Phillips head machine screws. Using a straight edge under the hull bottom, set the "negative angle" of the tab's trailing edge (See Figure 6). 9" chord tabs should have a negative angle of 1/2", and 12" chord tabs should have a negative angle of 5/8".

Figure 6

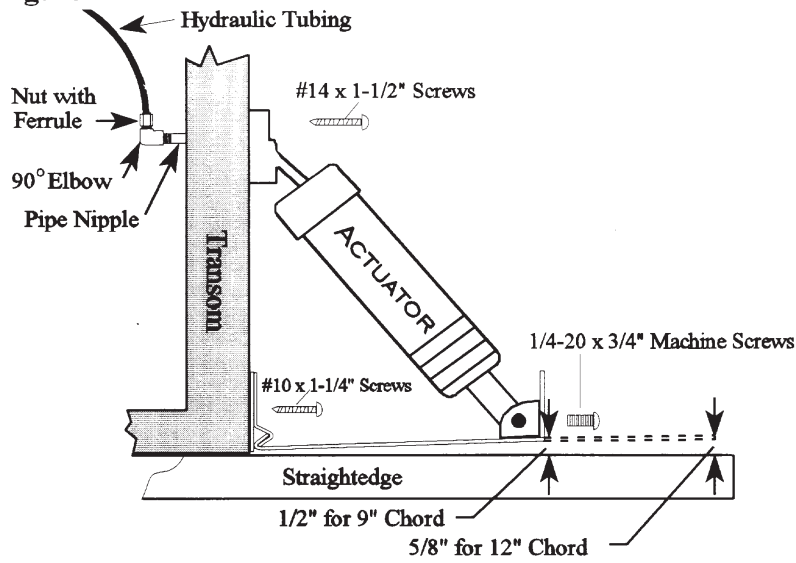

TIP: Run a screw into, or fix a block of wood to the straight edge to hold tab at the correct negative angle.

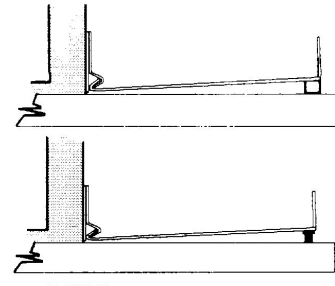

Step 4 — With tabs set at a negative angle, position the upper mounts of the actuators against the transom. Slide the actuator template behind upper mount, align and tape to transom. It is not necessary that the upper mounts lie flat against the transom as the actuator neck has the ability to flex far more than necessary (See Figure 7). The straight edge may now be removed. Drill holes accurately as indicated on templates. Drilling a small pilot hole first helps you locate accurate centers.

Step 5 — Install the pipe nipples (dry) snugly into the actuator upper mounts. Do not use Teflon tape. *Use care to avoid cross threading and do not over tighten (Turn in nipple finger tight, then two full turns with vise grips, NO MORE).* Apply waterproof sealant on surface around pipe nipple and screw holes. Insert pipe nipples through transom and secure actuator upper mounts to transom with #14 x 1-1/2" screws. **Note:** Cover the ends of the pipe nipples with masking tape to prevent dirt or debris from entering the system. Remove masking tape before making connections inside the boat.

Figure 7

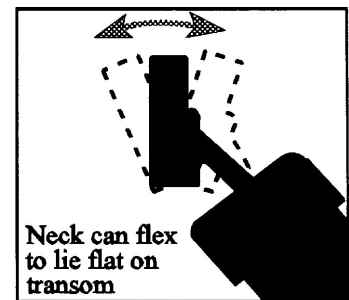

Step 6 — Install Hydraulic Power Unit (HPU) in a convenient location with a dry environment. **Important:** The HPU must be mounted in a dry enough location to avoid submersion and drenching. Allow space above the HPU so that it may be slid into its mounting bracket (about 3"). Lay out upper holes on HPU mounting bracket 4-5/8" apart and start #10 x 1" screws using 5/32" pilot holes. Then drill 5/32" pilot holes for lower screws and secure bracket. Slide HPU into bracket.

Step 7 — Inside the transom, apply Teflon tape on male threads of pipe nipples and tighten 90 degree brass elbows to pipe nipples. *While tightening elbow, hold pipe nipple with vise grips to prevent stripping actuator upper mount threads.*

Step 8 — Run hydraulic tubing from brass elbows to HPU and cut to length. **Note:** Make port and starboard lengths as equal as possible. Put masking tape on tubing ends to prevent debris from entering system. Remove masking tape before making connections. Use tube bending clips at desired 90 degree bends in tubing to prevent kinking.

connections. Use tube bending clips at desired 90 degree bends in tubing to prevent kinking.

Step 9 — At brass elbow, insert tubing through the nut with ferrule. Push until it bottoms in the fitting. While continuing to bottom the tubing in the fitting, tighten nut “finger tight,” then one full turn with a ½" wrench ... no more. (See Figure 8).

Step 10 — With plastic hangers, secure hydraulic tubing along hullside or bulkheads to HPU. When facing HPU, the brass fitting on the left of the pump face connects with the tubing from the port actuator, the fitting on the right connects with tubing from the starboard actuator. These fittings are identified “P” & “S” for port and starboard by small letters directly above each one. To connect tubing to the pump, insert tubing through the nut with ferrule fitting and push into the pump-face fitting until it bottoms. While continuing to bottom the tubing in the fitting, tighten nut “finger tight,” then one full turn with a ½" wrench ... no more.

Step 11 — Connect HPU ground wire to any convenient ground. Then run wiring harness from HPU to helm. (Follow control installation instructions enclosed with your control.)

Step 12 — Remove plug from filler stack located at the front left corner of the reservoir. Fill reservoir to “Full Line” using **any type automatic transmission fluid (ATF)**. (Hint: An easy way to fill reservoir is to detach the hydraulic tubing from the actuator and insert into a quart container of ATF. Then activate the control “Bow Up” for the corresponding side, until reservoir is full. Reconnect fitting, taking care not to over-tighten.)

Step 13 — Using the control, hold the “Bow Down” position for 15 seconds, then “Bow Up” for 15 – 20 seconds. Repeat 3 times. This will purge any air from the system. No bleeding is necessary.

Step 14 — Place both tabs in the “full down” position and check all hydraulic connections for leaks. Bring the tabs to the full up position and check fluid level. Add ATF if necessary.

Figure 8

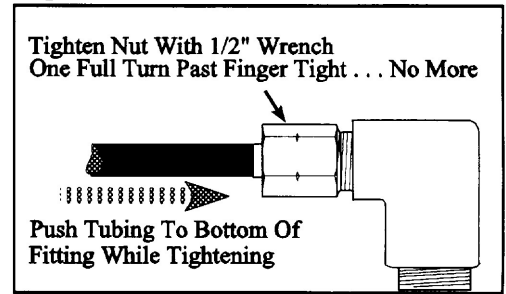

IMPORTANT NOTE FOR BOATS KEPT IN SALT WATER:

To provide protection from electrolytic corrosion, a zinc anode must be applied to each tab. Do not ground tabs to other underwater appendages. Failure to provide zinc anode protection can result in the trim tabs being damaged by electrolysis.

Trim tabs should be painted with anti-fouling paint to prevent fouling and surface oxidation. Follow paint manufacturer's recommendations for proper priming and painting of 304 stainless steel.

Note: Do not paint under zincs in order to achieve maximum electrical contact with trim tabs.

PLEASE KEEP THIS SHEET AND TRIM TAB OWNER'S MANUAL WITH YOUR BOAT'S OPERATING MANUALS.

