

# HL1000 Single Cylinder Retrofit Hatch Lifter System

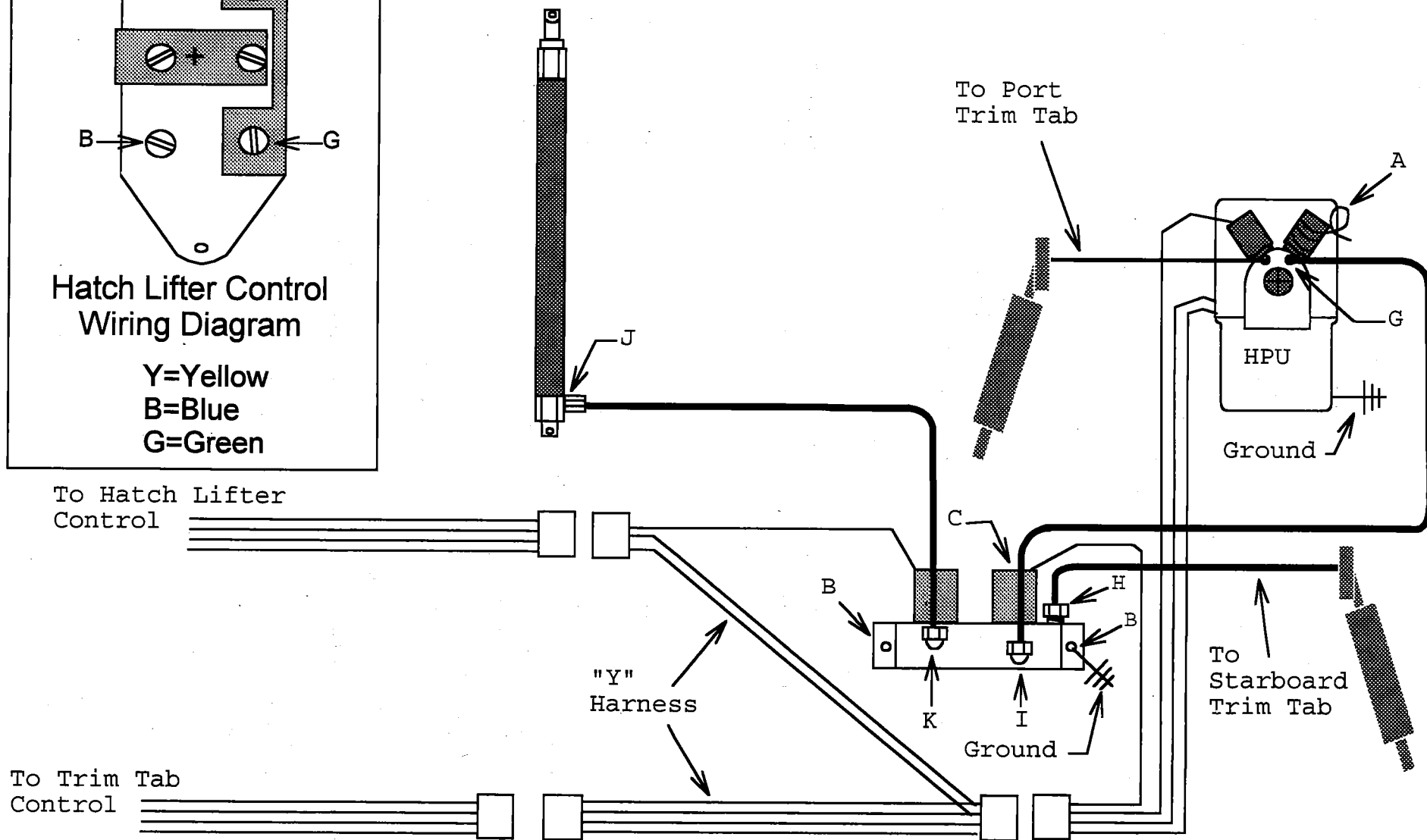

# HL2000 Dual Cylinder Simultaneous Movement Retrofit Hatch Lifter System

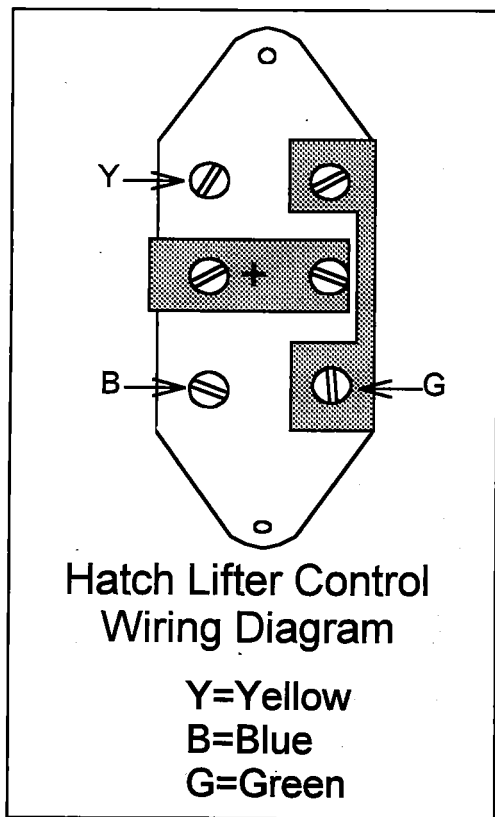
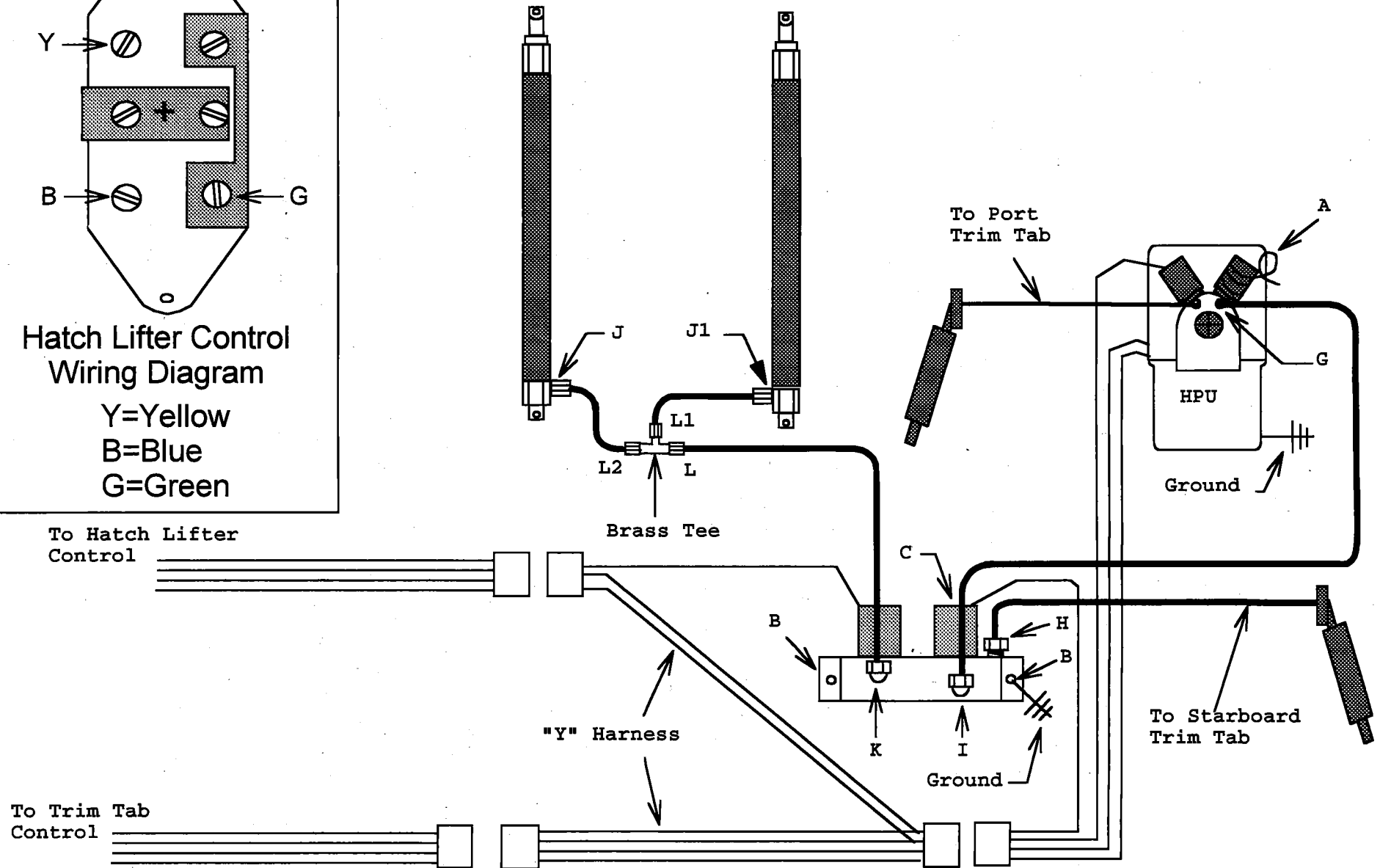
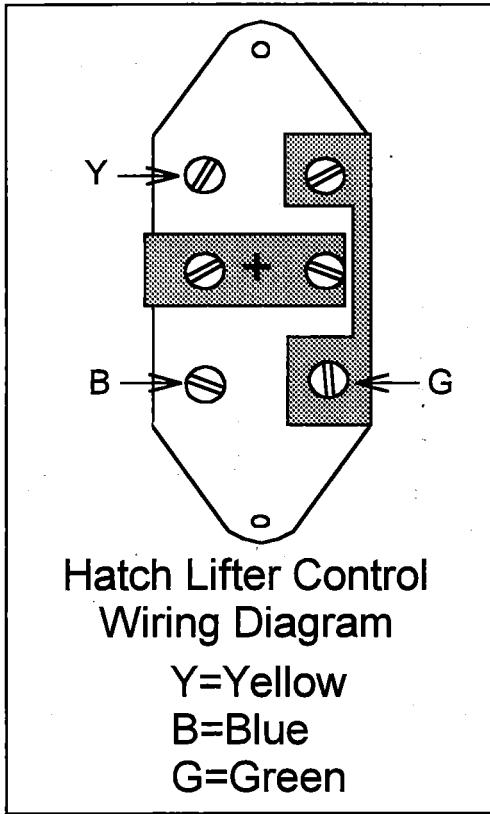

# HL3000 Dual Cylinder Independent Movement Retrofit Hatch Lifter System

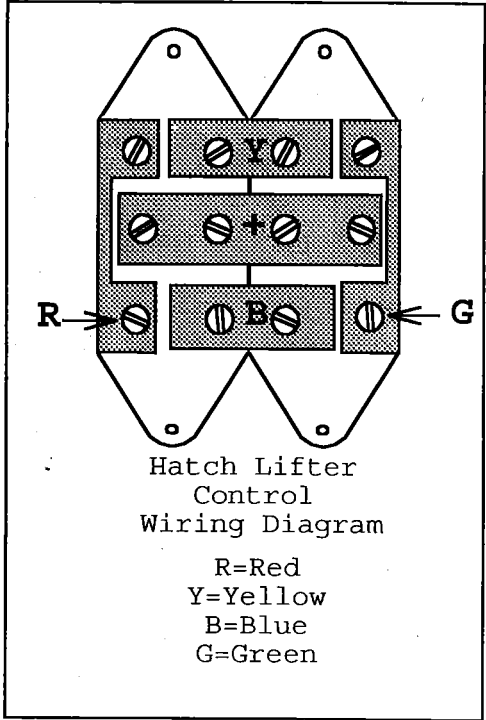
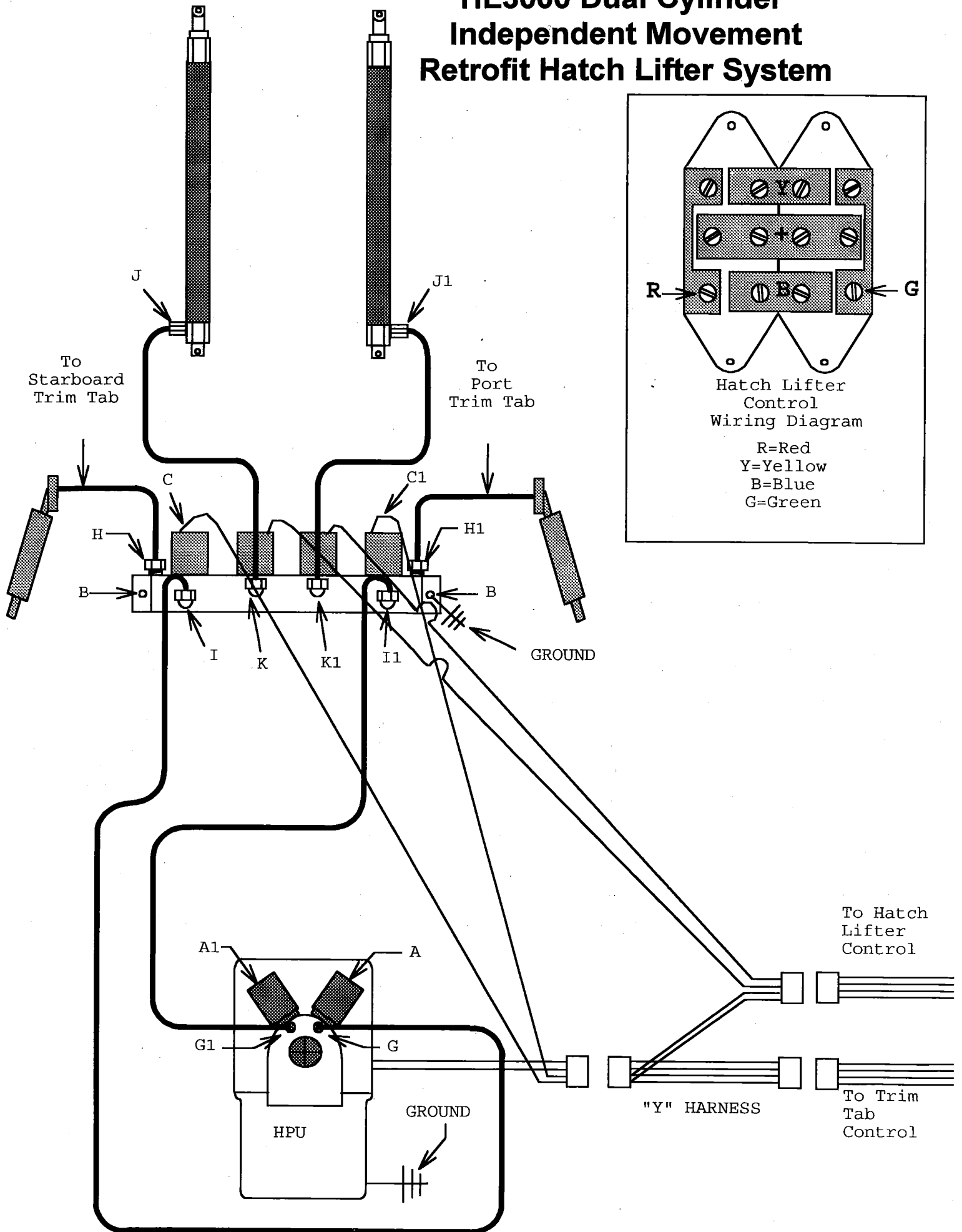

# HL1351 Single Cylinder Independent Hatch Lifter System

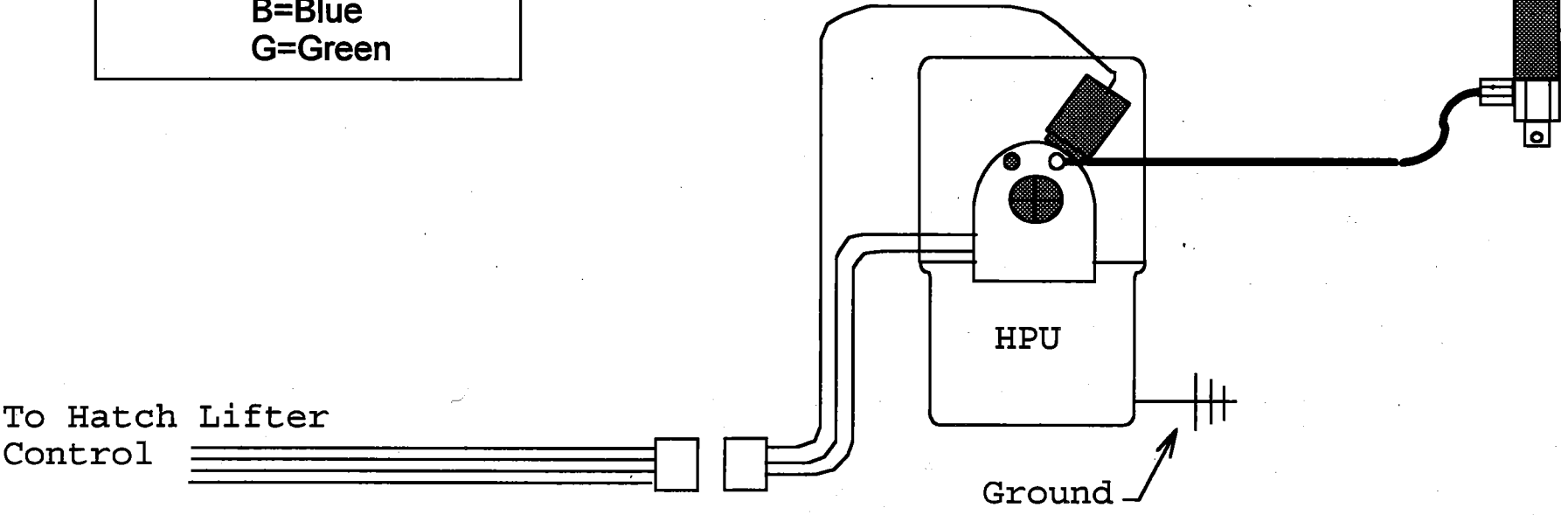
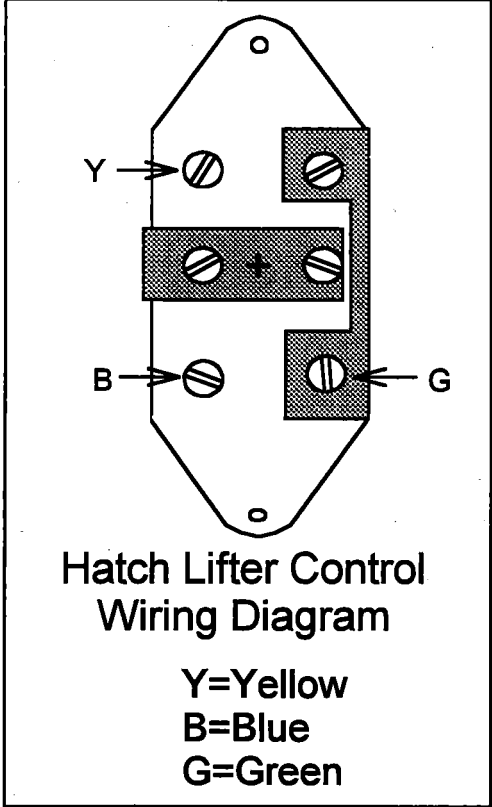

# HL1351DA Dual Acting Independent Hatch Lifter System

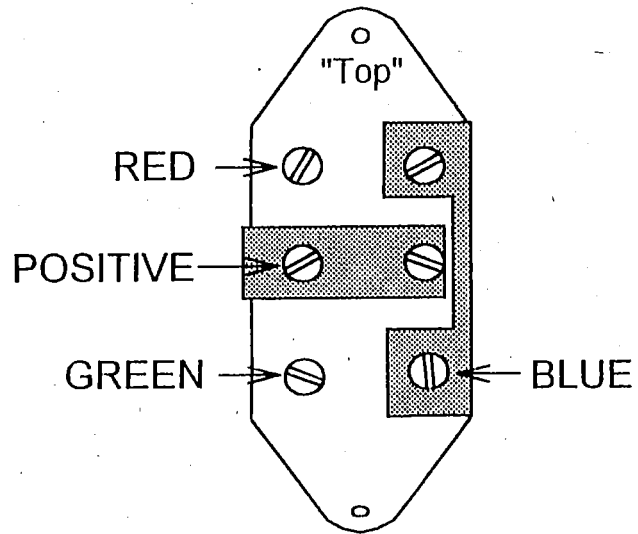

Hatch Lifter Control  
Wiring Diagram  
Yellow Wire Is Not  
Used

To Hatch Lifter  
Control

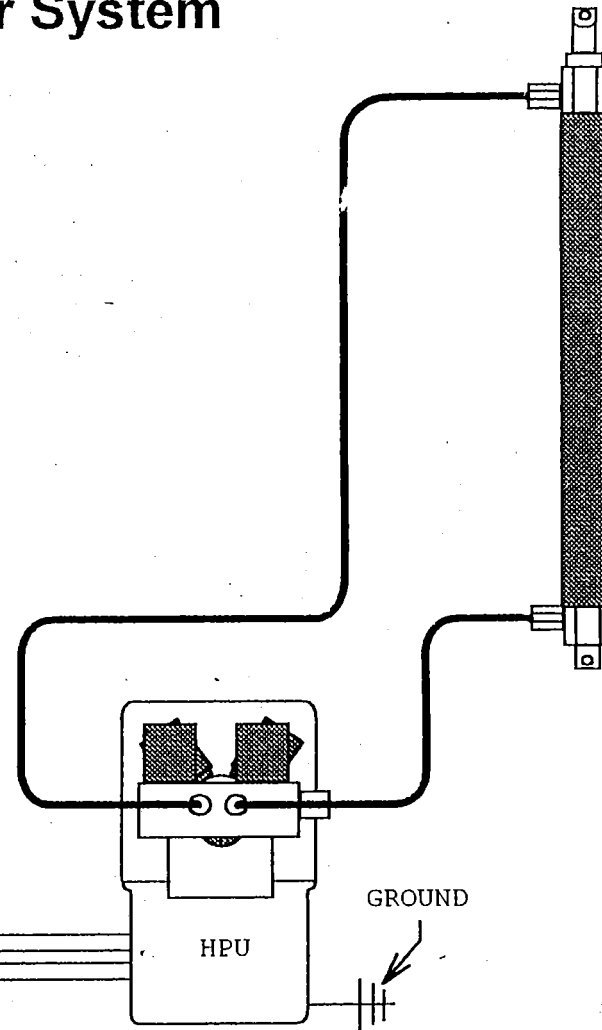
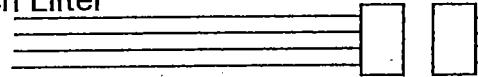

GROUND

# HL2351 Dual Cylinder Simultaneous Movement Independent Hatch Lifter System

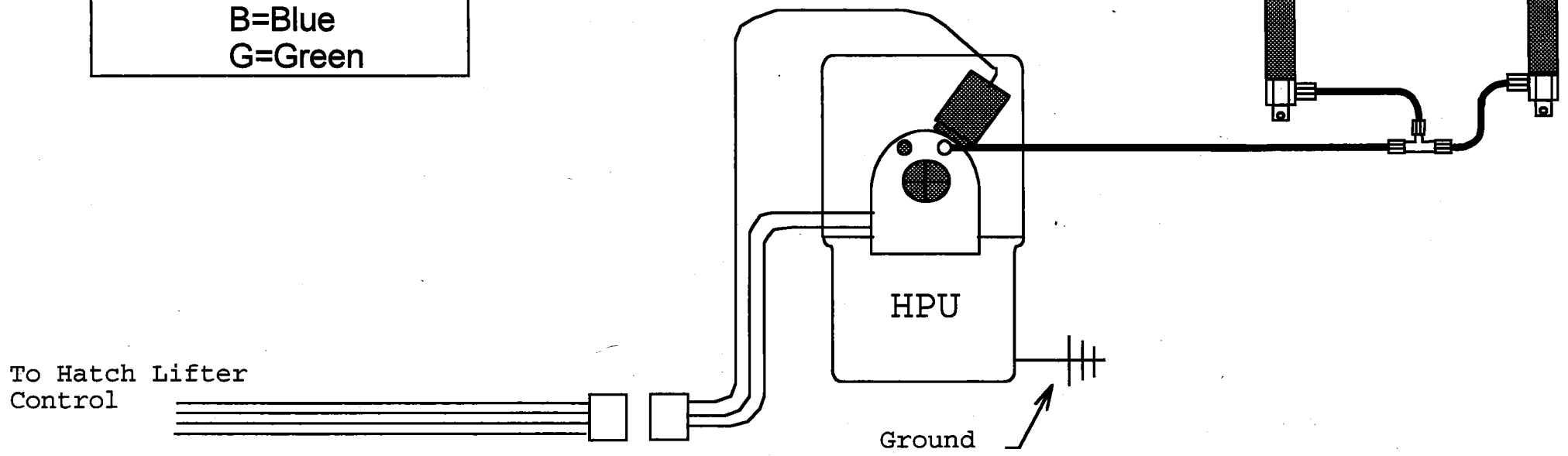
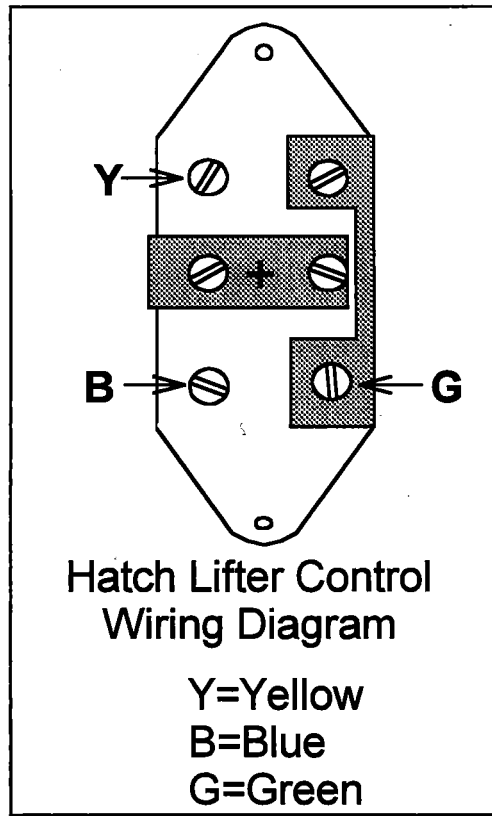

**HL2351DA Dual Acting  
Dual Cylinder Simultaneous  
Movement Independent  
Hatch Lifter System**

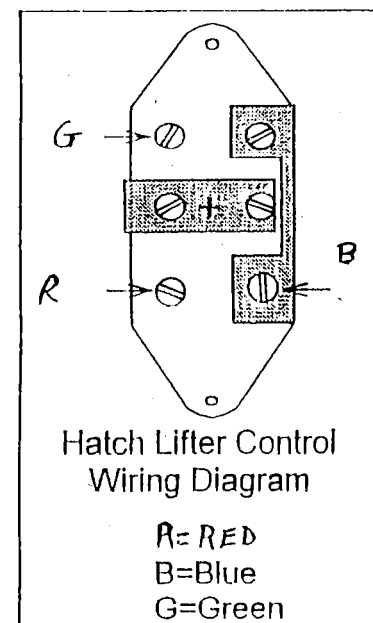
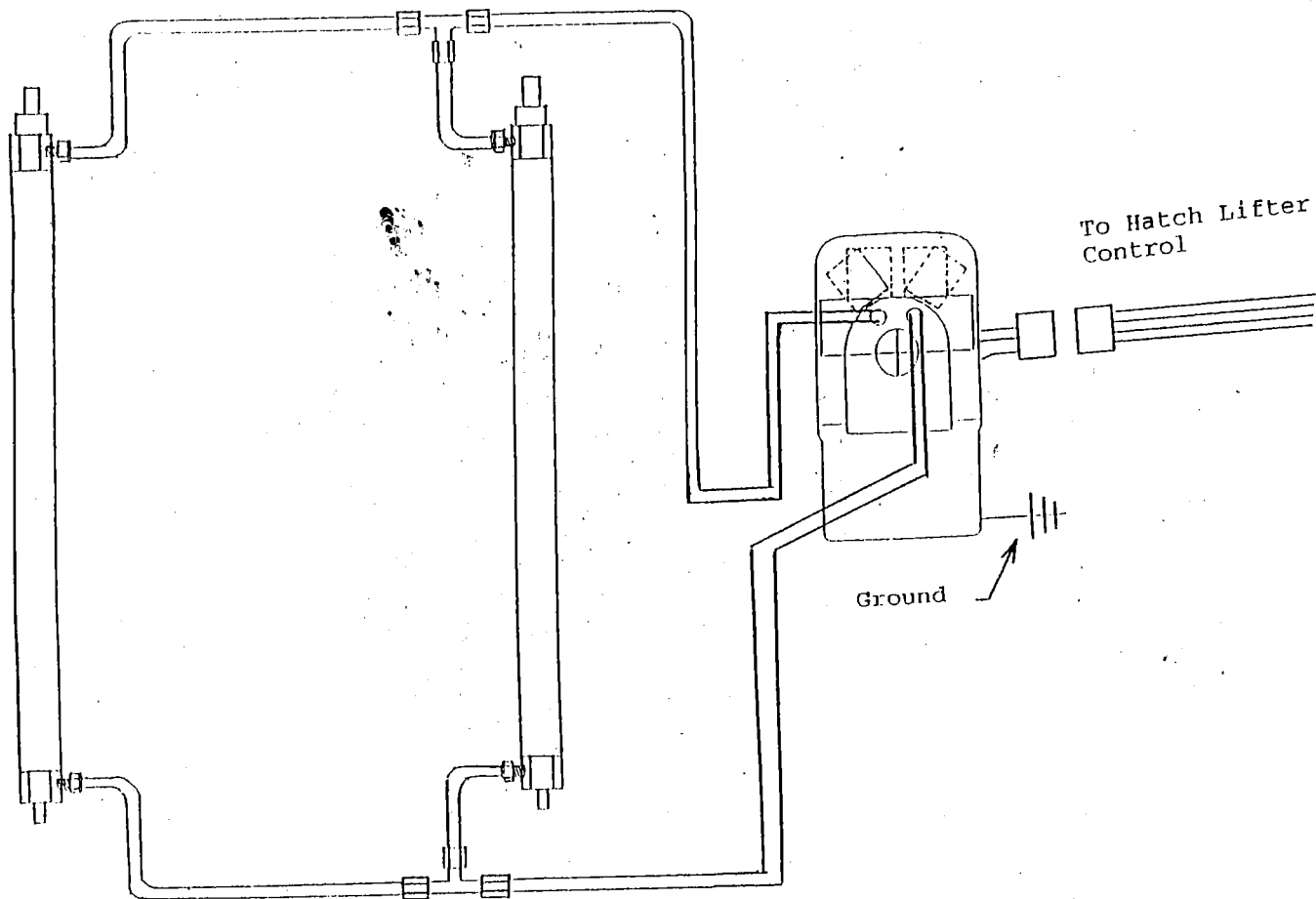

# HL3351 Dual Cylinder Independent Movement Independent Hatch Lifter System

