

For information on installing a complete Bennett Hydraulic Trim Tab System, please visit [BennettTrimTabs.com/Installation](http://BennettTrimTabs.com/Installation)

## Before Installation

Before drilling any holes, read the entire instructions and make sure battery power is disconnected.

## Special Requirements

- Make sure to test system before putting the boat back in the water.
- System is voltage specific. Please make sure you have a 12 or 24 volt EIC5000 depending on your requirements.
- Special sensor coils are required if (See figure 1):
  - » Actuator stroke is more than 2 ½"
  - » Less than 1" of piston shaft is exposed when the actuator is fully retracted
  - » Actuator has external hydraulic connection
- System will not work when actuator stroke is 1" or less
- This kit contains sensor rods for the two most popular sizes of Bennett Classic Actuators. Use the short rods if your actuators have three rings on the bottom of the cylinder. Use the long rods if your actuators have four rings on the bottom of the cylinder.

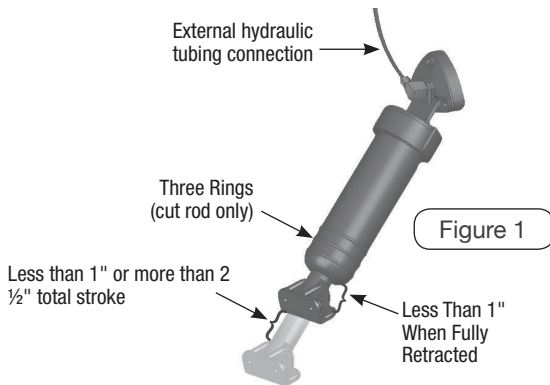

## Required Tools and materials

- |                                       |                  |                        |
|---------------------------------------|------------------|------------------------|
| • 7/16", 1/2" & 9/16" Wrench          | • 1" Hole Saw    | • Marine Grade Sealant |
| • 1/8", 3/16", 5/16" & 3/4" Drill Bit | • Teflon Tape    | • Vise Grips           |
|                                       | • Wire Stripper  | • Wire Cutter          |
|                                       | • Electric Drill |                        |

## Installation Instructions

**Important:** If you are installing a pre-assembled actuator with the sensor wires already included, skip to step 6.

### Installing New Upper Hinge with Sensor

**Step 1** - Inside transom, with tabs in full up position, locate trim tab hydraulic line. If there is no pipe nipple visible inside the transom, you have a short through-transom fitting connection, (see Figure 2). Unscrew and remove actuator away from the transom and use a 7/16" wrench to remove the tubing from the upper hinge. Skip to step 3.

For standard installations, detach tubing from brass elbow (some fluid will drip out). While holding pipe nipples with vise grips, unscrew brass elbow using 9/16" wrench. Do this procedure for port and

starboard cylinders (see Figure 3).

**Step 2** - Outside transom, unscrew and remove actuator away from the transom. Remove pipe nipple.

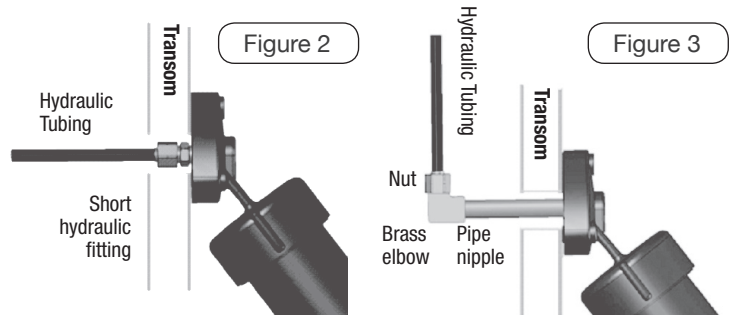

**Step 3** - Start with the port side cylinder. Snap white plastic clip on shaft protruding from bottom of cylinder.

**Important:** This clip must be used to keep the spring inside the cylinder compressed. Grasp cylinder upper hinge with both hands and unscrew it counterclockwise from the cylinder body (a small amount of fluid may spill).

**Step 4 - Important:** Use care when handling sensor coils during assembly to avoid damaging wires. Insert metal rod into piston, pointed end down. Make sure that the O-ring is in place in new upper hinge with sensor coil. Screw new upper hinge with red Sensor Wire onto the port side cylinder while keeping metal rod inserted into center of sensor coil (see Figure 4). Tighten upper hinge hand tight. You will finish tightening cylinder in Step 7.

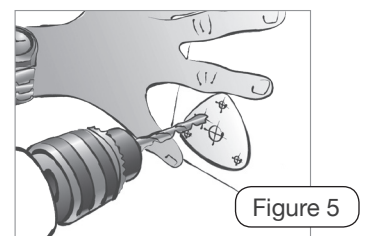
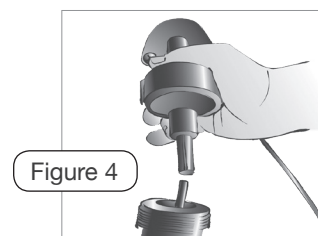

**Step 5** - Remove plastic clip from piston and repeat steps 2 - 4 for the starboard cylinder. Use upper hinge with green Sensor Wire for the starboard side.

**Step 6** - Using included template, drill 5/16" hole in transom for the Sensor Wire (see Figure 5 above). Screw pipe nipple into actuator upper hinge. Tighten nipple hand tight. Then, with vise grips, tighten two full turns ... NO MORE. Cover end of pipe nipple with masking tape. If you have the short through-transom fitting, using a 7/16" wrench, screw it in until the fitting is snug; the shoulder of the fitting will just touch the plastic of the upper hinge.

**Step 7** - Carefully feed Sensor Wire through 5/16" hole. Apply sealant to actuator upper hinge surface around pipe nipple, screw holes, and cable. Secure actuator upper hinge to transom with mounting screws. Grasp cylinder body with both hands and tighten (clockwise) securely.

**Step 8** - Inside transom, remove masking tape from pipe nipples. Carefully wrap Teflon tape around male threads of pipe nipples. Holding pipe nipples with vise grips (to prevent them from turning) re-secure 90 degree elbows. Re-attach hydraulic tubing, tightening nut finger tight. Snug nut with 1/2" wrench. Do not over-tighten. Note: If you have the short through-transom fittings, omit this step. Repeat for other side. Run red and green Sensor Wires to where you plan to mount the EIC Module.

**Step 9 - Mounting the EIC Display** using the template on the last page, mark the location for your EIC Display and locate the centers of the holes. Use a 1" hole-saw to cut the center hole and 3/16" drill for the four mounting stud holes. Use a small bead of sealant around the perimeter of the display to seal. Plug the EIC Harness (blue cable) into the back of the EIC Display. Use the 4 nylon thumb nuts to secure the display (use care to avoid over-tightening).

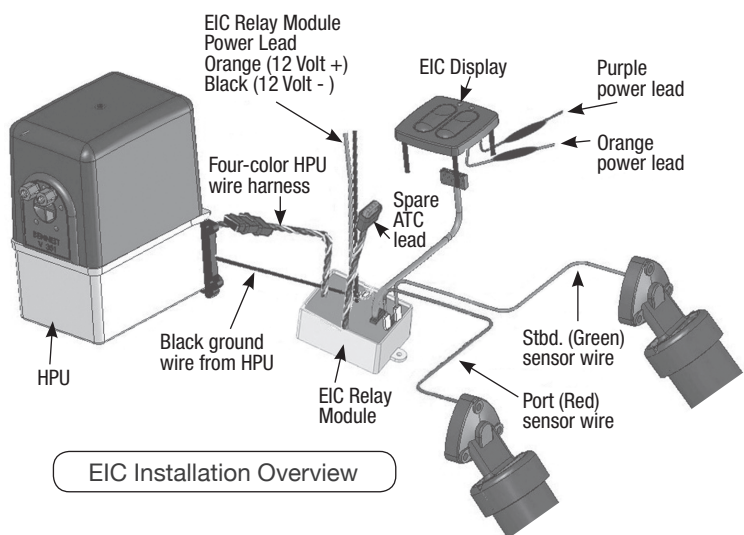

**Step 10 - Mounting the EIC Relay Module.** The Module is best located in a dry location close to the Hydraulic Power Unit. Use the mounting hardware to secure it in place.

**Step 11 - Running the EIC Wire Harness from the Display to the Module.** Run the EIC Harness to the location you have selected for the EIC Relay Module. Plug the EIC Wire Harness into the EIC Relay Module. The cable must be properly strain relieved and secured with cable ties. For best results, create a drip loop.

**Step 12 - Connecting the Wiring for the EIC.** Purple wire with inline 1.5 amp fuse: Connect to ignition switch or any 12 volt circuit that turns ON and OFF with ignition. This wire is used to initiate Auto Tab Retraction when the ignition is switched to the OFF position. If Auto Tab Retraction is not desired this connection may be omitted.

*Orange wire with inline 1.5 amp fuse: To source that supplies power to boat's electronics and or gauges. This wire powers the display and must be installed.*

## Making Electrical Connections (See Figure 6)

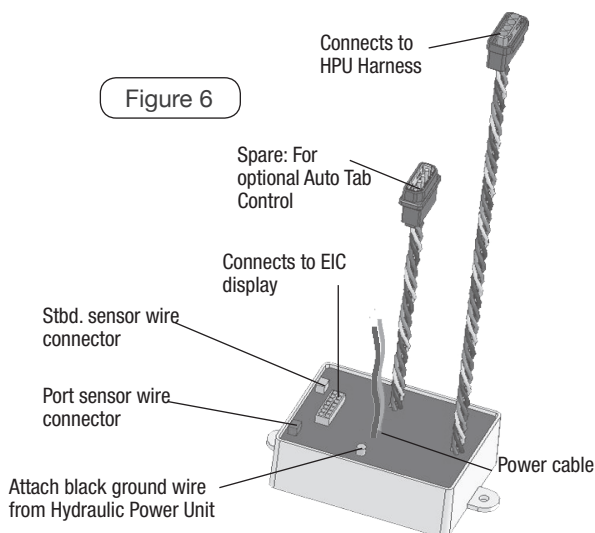

**Ground wire from pump:** Run the black ground wire from the back of the hydraulic power unit to the grounding stud on the Relay Module. Crimp the supplied ring terminal on wire and secure with 10-32 hex nut.

**HPU Connection:** Plug the 4-color wire harness from the Hydraulic Power Unit into the 4-color output cable (longer of the two harnesses) on the EIC Relay Module.

**Sensor Wires:** Plug green Sensor wire into the green Wire Connector (starboard) on the EIC Module. Plug red Sensor Wire into the red Wire Connector (port) on the EIC Module.

**Power Cable:** Attach the black wire to 12 volt negative ground and the orange wire with inline 20 amp fuse to 12 volt positive source. Power source must be capable of supporting 20 amps.

**Auto Tab Control:** (Shorter of two harnesses) This plug is used to interface a Bennett Auto Tab Control into the EIC System. Please refer to Auto Tab Control Installation Instructions. If no Auto Tab Control is installed this lead is not used.

## Calibration and Operation

- Note:** If you have Upper and Lower Helm EIC Displays installed, calibration must be done at the Primary EIC Display (connected to the EIC301 - thick gray cable). Reconnect the battery power to begin the calibration process. Check trim tab system to ensure it is operational, then put both trim tabs in the full up position by holding down the "Bow Up" position.

- The port and starboard red LEDs will flash alternately, indicating that the system is not calibrated.
- Press and hold the sun and moon buttons on the EIC Display simultaneously for approximately 3 seconds. Both the port and starboard lower yellow LEDs will begin to flash. Release the sun and moon buttons.
- Using the EIC Display, run both trim tabs to the full down position (Bow Down on the control). Make sure the tabs go all the way DOWN by holding the buttons down for at least 15 seconds or until the lower yellow LEDs stop flashing. (Holding the buttons after the tabs are down will not harm the system).

4. A few seconds after the tabs are all the way down the port and starboard upper yellow LEDs will begin flashing. Again, using the EIC Display, run both tabs to the full up position (Bow Up on the control). Make sure the tabs come all the way UP by holding the buttons down for at least 15 seconds or until the upper yellow LEDs stop flashing.
5. The upper and lower yellow LEDs will then light up solidly, indicating that the EIC is calibrated and ready to operate. If you wish to recalibrate the EIC at any time, simply bring the tabs to the full up position, press and hold the sun and moon buttons down and repeat the calibration instructions.

### Operation

The brightness of the display may be adjusted by pressing the sun button to brighten and the moon button to dim the display.

### Diagnostic Information

- **Port and starboard red LEDs alternately flash:** EIC requires calibration. Follow steps above.
- **Upper yellow LED flashes on port or starboard side:** Indicates the EIC Display is not receiving a sensor signal. If the port upper yellow LED flashes, the fault is in the port (red) sensor or wires. A flashing yellow LED on the starboard side would indicate a fault on the starboard (green) sensor or wires. Switching the sensor connections on the EIC Relay Module will confirm the diagnostic code if the flashing LED switches sides. If the problem switched sides, check the suspected faulty actuator with an Ohm meter at the EIC sensor cable plug. The reading should be in the 220-260 Ohm range. If the sensor readings are good, check for faulty connections (corrosion or broken wires).

### Electro-Hydraulic System Information

- **EIC Relay Module Fuse:** 12 volt system uses 20 amp in-line fuse on positive, 24 volt uses 10 amp. EIC Display Fuses: Both Purple and Orange wire fused at 1.5 amp for both 12 and 24 volts.

### Hydraulic Power Unit and EIC Module Wiring

Red = Port Valve  
 Green = Starboard Valve  
 Yellow = Motor Reverse (pump retract)  
 Blue = Motor Forward (pump pressure)  
 Black on HPU = Connects to Ground Stud on EIC Module  
 Orange on EIC Module = Positive  
 Black on EIC Module = Ground (boat's electrical system)

## Troubleshooting

(This general information is not intended to be complete. Please feel free to contact Bennett Marine at 866.894.1626 or visit our website at BennettTrimTabs.com for additional information.)

**If Trim Tabs do nothing, no movement, no sound from HPU:** Inspect 20 amp fuse on orange wire at Relay Module and 1.5 amp fuse on orange wire at display. Inspect all wiring for disconnected or corroded connections.

**HPU running but Trim Tabs do not move, or will go down but not retract:** Is unit receiving solid 12 volts to EIC Module? Low voltage will sometimes cause solenoids to not open preventing the tabs from moving even though the pump motor is running. Inspect all wiring for disconnected or corroded connections.

Conduct the following test using the "Spare for Auto Tab Control" connector at the EIC Module:

### Operation = Reaction

Apply 12 volts (+) to blue, red = Port trim tab down  
 Apply 12 volts (+) to blue, green = Starboard trim tab down  
 Apply 12 volts (+) to blue, red, green = Both trim tabs down  
 Apply 12 volts (+) to yellow, red = Port trim tab up  
 Apply 12 volts (+) to yellow, green = Starboard trim tab up  
 Apply 12 volts (+) to yellow, red, green = Both trim tabs up

If the trim tabs function correctly for each wire grouping, then the Display or EIC Wire Harness is at fault.

If the system does not function properly, then conduct the same test using the wire harness connected to the HPU. If the trim tabs function correctly then the Module is faulty. If the trim tabs do not function correctly, the HPU is at fault.

Have questions?

**We're here to help.**

Call us at (866) 894-1626.



**BENNETT MARINE**

# Electronic Indicator Control (EIC5000) Drilling Template

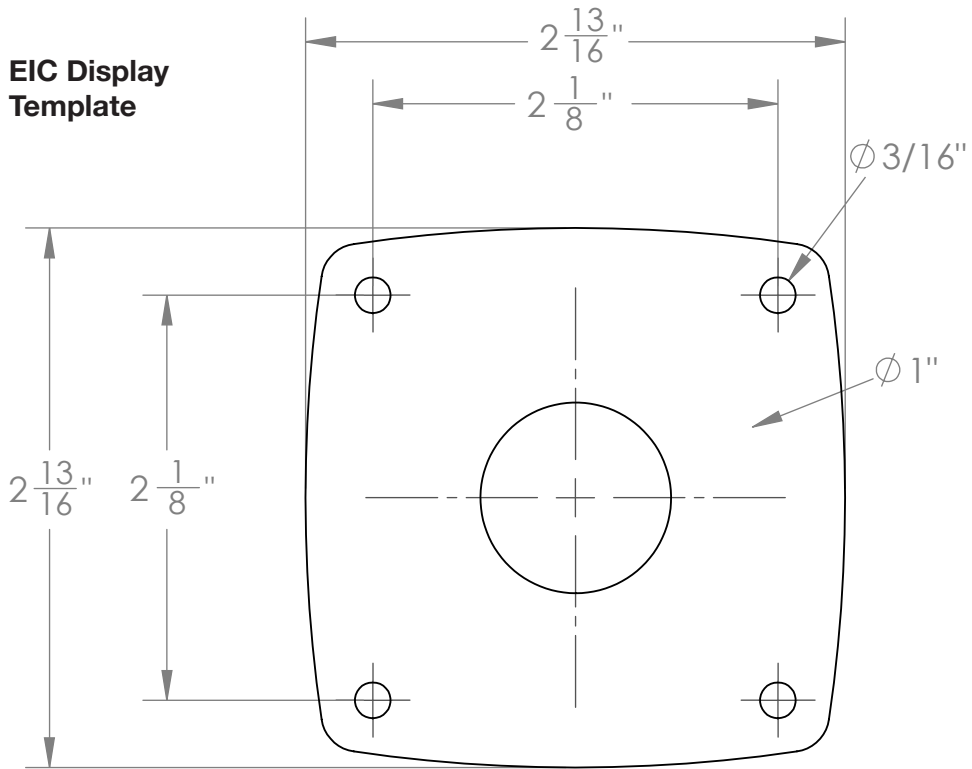

## Actuator Upper Hinge Templates

